

PNP Silicon Epitaxial Planar Transistor

B772

FEATURES

- Low speed switching.
- Low saturation voltage.
- Excellent h_{FE} linearity and high h_{FE} .
- Complementary: D882.

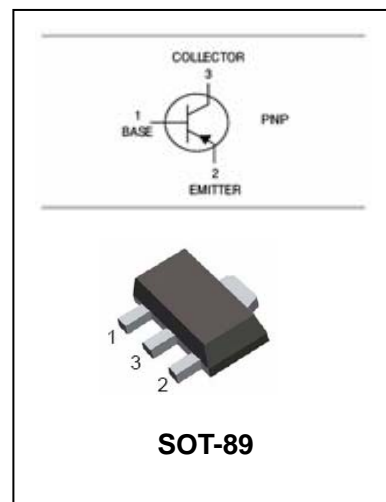

APPLICATIONS

- Audio frequency power amplifier.

ORDERING INFORMATION

Type No.	Marking	Package Code
B772	B772	SOT-89

MAXIMUM RATING @ Ta=25°C unless otherwise specified

Symbol	Parameter	Value	Units
V_{CBO}	Collector-Base Voltage	-40	V
V_{CEO}	Collector-Emitter Voltage	-30	V
V_{EBO}	Emitter-Base Voltage	-5	V
I_C	Collector Current -Continuous	-3	A
P_C	Collector Dissipation	500	mW
T_j, T_{stg}	Junction and Storage Temperature	-55 to +150	°C



PNP Silicon Epitaxial Planar Transistor

B772

ELECTRICAL CHARACTERISTICS @ Ta=25°C unless otherwise specified

Parameter	Symbol	Test conditions	MIN	TYP	MAX	UNIT
Collector-base breakdown voltage	$V_{(BR)CBO}$	$I_C=-100\mu A, I_E=0$	-40			V
Collector-emitter breakdown voltage	$V_{(BR)CEO}$	$I_C=-10mA, I_B=0$	-30			V
Emitter-base breakdown voltage	$V_{(BR)EBO}$	$I_E=-100\mu A, I_C=0$	-6			V
Collector cut-off current	I_{CBO}	$V_{CB}=-40V, I_B=0$			-1	μA
Collector cut-off current	I_{CEO}	$V_{CB}=-30V, I_E=0$			-1	μA
Emitter cut-off current	I_{EBO}	$V_{EB}=-6V, I_C=0$			-1	μA
DC current gain	h_{FE}	$V_{CE}=-2V, I_C=-1A$ $V_{CE}=-2V, I_C=-20mA$	60 30	160 220	400	
Collector-emitter saturation voltage	$V_{CE(sat)}$	$I_C=-2A, I_B=-0.2A$		-0.3	-0.5	V
Base-emitter saturation voltage	$V_{BE(sat)}$	$I_C=-2A, I_B=-0.2A$		-1.0	-2.0	V
Transition frequency	f_T	$V_{CE}=-5V, I_C=-0.1A$		80		MHz
Collector output capacitance	C_{ob}	$V_{CB}=-10V, I_E=0, f=1MHz$		55		pF

CLASSIFICATION OF h_{FE}

Rank	R	O	Y	G
Range	60-120	100-200	160-320	200-400



PNP Silicon Epitaxial Planar Transistor

B772

TYPICAL CHARACTERISTICS @ Ta=25°C unless otherwise specified

STATIC CHARACTERISTIC

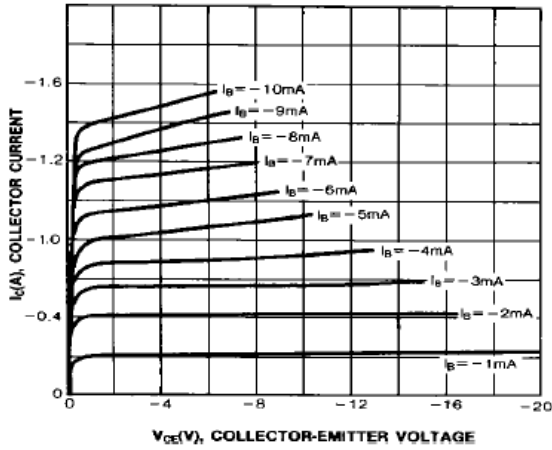

DC CURRENT GAIN

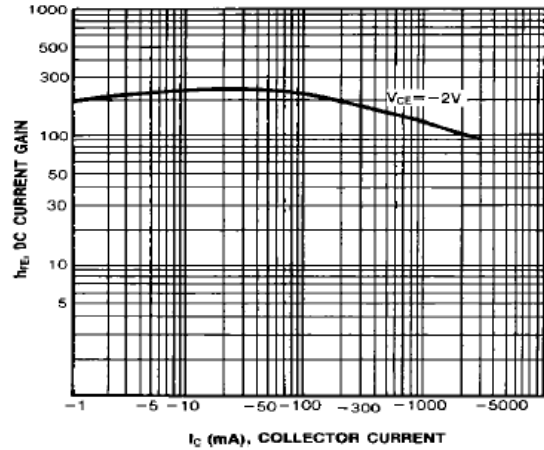

BASE-EMITTER SATURATION VOLTAGE
COLLECTOR-EMITTER SATURATION VOLTAGE

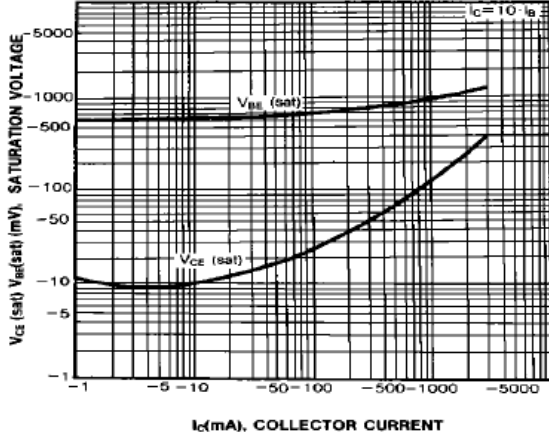

COLLECTOR OUTPUT CAPACITANCE

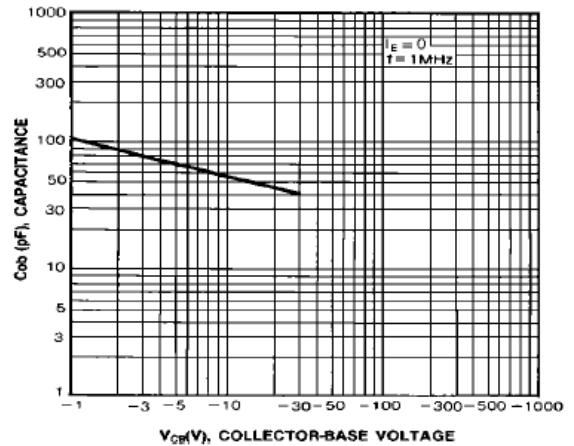

CURRENT GAIN-BANDWIDTH PRODUCT

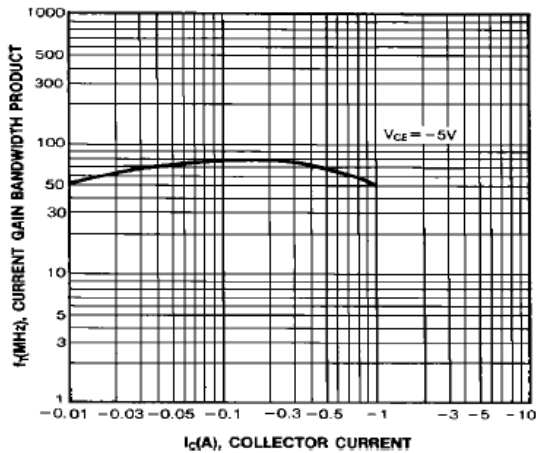

SAFE OPERATING AREA

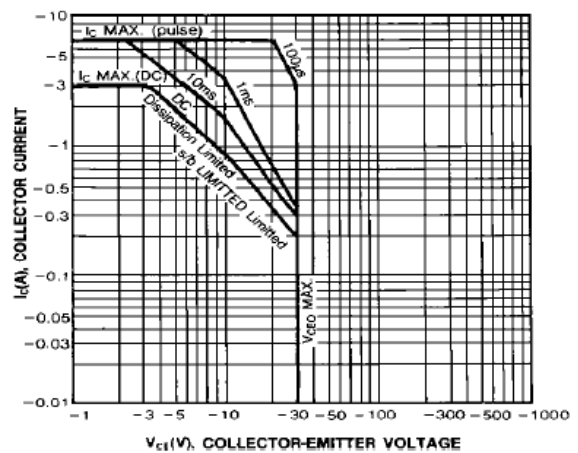

PNP Silicon Epitaxial Planar Transistor

B772

PACKAGE OUTLINE

Plastic surface mounted package

SOT-89

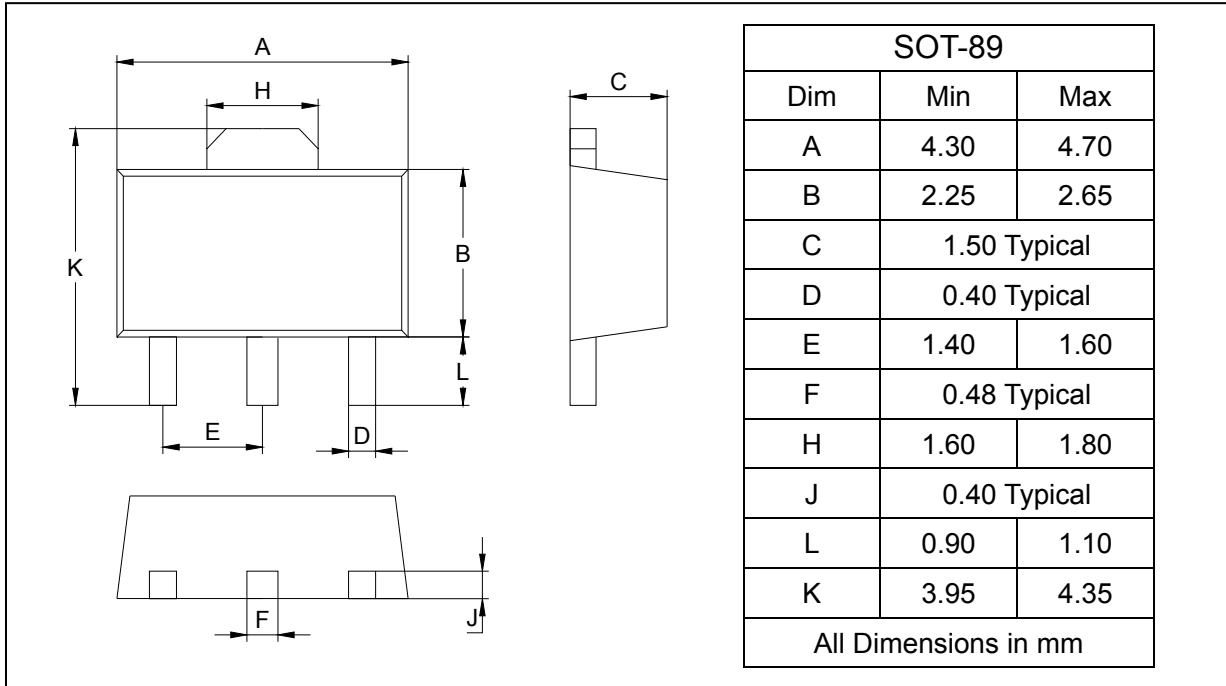

SOLDERING FOOTPRINT

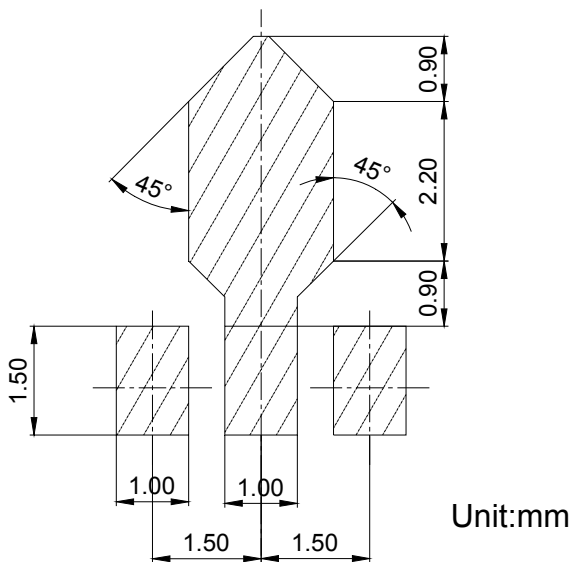

PACKAGE INFORMATION

Device	Package	Shipping
B772	SOT-89	1000/Tape&Reel